

KATALOG STANDARDNIH OPRUGA

ZASTAVA, LADA, ŠKODA, 125 P

<p>Opruga sedišta L-400 Zastava 750; Zastava 101</p>	<p>Oruga kvake - prednja leva i desna vrata Yugo - Rival</p>
<p>interni broj: 98</p>	<p>interni broj: 195</p>
<p>Opruga pakna - donja (kraća) Zastava 750; Zastava 101</p>	<p>Plastična kapica za ventil Zastava 750; Zastava 101</p>
<p>interni broj: 76</p>	<p>interni broj: /</p>
<p>Opruga pakna - gornja (duža) Zastava 750; Zastava 101</p>	<p>Opruga kvačila Škoda - svi tipovi</p>
<p>interni broj: 77</p>	<p>interni broj: 92</p>
<p>Opruga kvačila 1300; 125p; Lada</p>	<p>Žabica za stezanje tapacirunga</p>
<p>interni broj: 93</p>	<p>interni broj: /</p>
<p>Osigurač "Omega" za ručicu prozora Zastava 750; Zastava 101</p>	
<p>KB. 408 SI 99 interni broj: 99</p>	

OPRUGE ANKER PLATNE - ZASTAVA KAMIONI

<p>Garnitura opruga anker platne OM - Z 650 17-1kom.; 18-2kom.; 19-1kom.; 20-1kom.</p>	<p>Opruga druk ležaja OM - Z 635/640/650</p>
<p>interni broj: 17,18,19,20</p>	<p>KB. 541369 interni broj: 24</p>
<p>Garnitura opruga anker platne 12-2kom.; 13-1kom.; 14-1kom.; 15-1kom.</p>	<p>Opruga potisne korpe - kraća OM - Z 635/640/650</p>
<p>OM - Z 635/640/650 interni broj: 12,13,14,15</p>	<p>KB. 162 47 24 interni broj: 33</p>
<p>Opruga paknova zadnjeg točka ručne kočnice OM - Z 635/640/650</p>	<p>Opruga potisne korpe - duža OM - Z 635/640/650</p>
<p>KB. 852 86 48 interni broj: 14</p>	<p>KB. 162 47 25 interni broj: 34</p>
<p>Opruga poluge kvačila - Z 635/640/650</p>	<p>Opruga anker platne Z 650, Turbo Zeta</p>
<p>KB.385 644 39 interni broj: 15</p>	<p>interni broj: 17</p>
<p>Opruga gornjih prednjih i zadnjih paknova OM - Z 635/640/650</p>	<p>Opruga anker platne OM - Z 650, Turbo Zeta</p>
<p>KB.190 13 82 interni broj: 12</p>	<p>interni broj: 18</p>
<p>Opruga donja - dupla Z 635/640/650</p>	<p>Opruga anker platne OM - Z 650, Turbo Zeta</p>
<p>KB. 853 86 20 interni broj: 13</p>	<p>interni broj: 19</p>
<p>Garnitura opruga potisne korpe kvačila 33-4kom.; 34-8kom.</p>	<p>Opruga anker platne OM - Z 650, Turbo Zeta</p>
<p>OM - Z 635/640/650 interni broj: 33, 34</p>	<p>interni broj: 20</p>
<p>Garnitura opruga anker platne - desna 2-1kom.; 3-1kom.; 4-2kom.; 5-1kom.; 6-4kom.</p>	<p>Garnitura opruga anker platne - leva 1-2kom.; 2-1kom.; 3-1kom.; 4-2kom.; 5-1kom.; 6-4kom.</p>
<p>Zastava - "RIVAL" interni broj: 330</p>	<p>Zastava - "RIVAL" interni broj: 331</p>

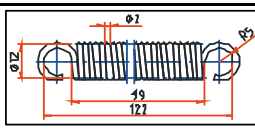
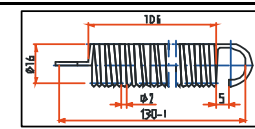
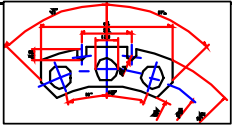
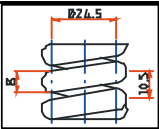
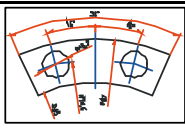
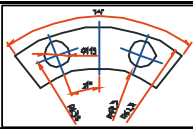
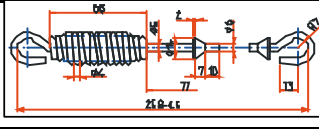
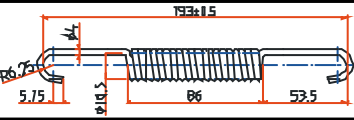
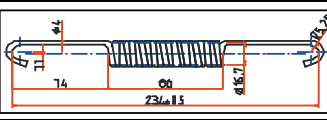
<p>Opruga gasa - povratna (manja) TAM - 5000 KB. 342 30 interni broj: 169</p>		<p>Garnitura opruga anker platne prednje osovine 38-4kom.; 88-4kom. TAM - 5000 interni broj: 38, 88</p>
<p>Opruga gasa - povratna (veća) TAM - 5000 interni broj: 168</p>		<p>Osigurač poluosovine AS - 3500 interni broj: 307</p> 
<p>Opruga ekscentra 5000/5500; AS - 3500 [D. 2390 112 interni broj: 130</p>	<p>TAM -</p> 	<p>Osigurač poluosovine AS - 4500/5000 interni broj: 308</p> 
<p>Garnitura opruga zadnje osovine 8-4kom.; 10-2kom.; 38-4kom. TAM - 5000 interni broj: 8, 10, 38</p>		<p>Osigurač poluosovine AS - 4500/5000 interni broj: 311</p> 
<p>Garnitura opruga zadnje osovine 10-2kom.; 27-4kom.; 28-4kom.; 87-2kom. TAM - 6500; 170T14; AS3500 interni broj: 10, 27, 28, 87</p>		<p>Opruga pakna TAM; GORICA interni broj: 312</p> 
<p>Opruga iznad sklopa za podešavanje TAM - 5000/5500; AS-3500 interni broj: 38</p>		<p>Povratna opruga obe prednje kočnice interni broj: 37</p> 

TAM 130; TAM 190; TAM 10B; TAM 11B

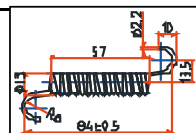
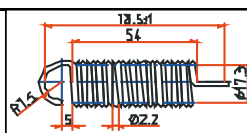
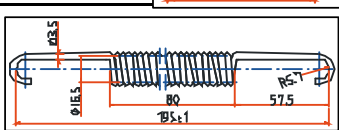
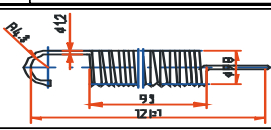
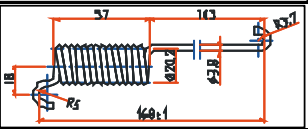
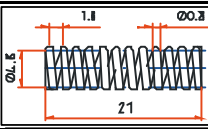
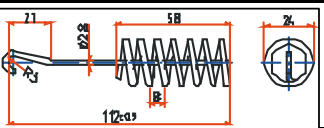
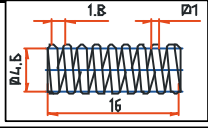
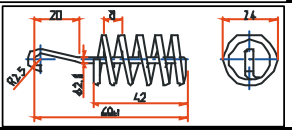
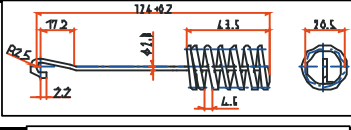
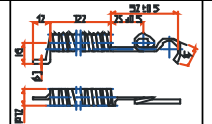
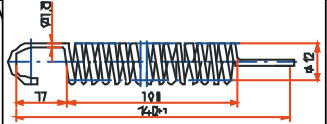
<p>Opruga ručne kočnice TAM 130/10B KB. 2473 536 interni broj: 122</p>		<p>Opruga kvačila 130/10B/11B TAM [D. 52 44 463 interni broj: 128</p> 
<p>Opruga zadnjeg pakna TAM 130/10B KB. 2473 537 interni broj: 124</p>		<p>Opruga gasa 130/10B TAM [D. 50 24 650 interni broj: 129</p> 
<p>Opruga zadnjeg pakna TAM 130/10B KB. 2473 538 interni broj: 125</p>		<p>Pritisna opruga 130/10B TAM KB. 2410 229 interni broj: 131</p> 
<p>Opruga zadnjeg pakna TAM 130/10B KB. 2473 540 interni broj: 126</p>		<p>Pritisna opruga 130 TAM KB. 2410 230 interni broj: 132</p> 
<p>Opruga prednjeg pakna TAM 130/10B/11B KB. 2473 518 interni broj: 127</p>		<p>Opruga pakna zadnje kočnice TAM 190 A11 interni broj: 116</p> 
<p>Opruga pakne zadnje kočnice TAM - 130 A10 interni broj: 117</p>		<p>Opruga 130/10B TAM KB.8009 039 [D. 250 00 47 interni broj: 170</p> 

TATRA / KAMAZ

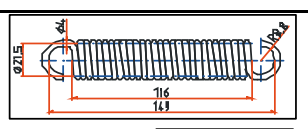
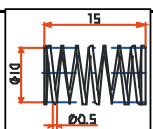
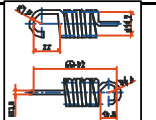
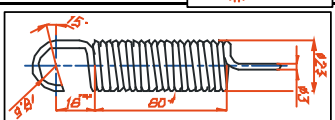
<p>Opruga paknova TATRA 148 interni broj: 6</p>		<p>Opruga kvačila TATRA 148 interni broj: 86</p> 
<p>Opruga ručne kočnice 148 TATRA interni broj: 94</p>		<p>Opruga kvačila KAMAZ interni broj: 324</p> 

Povratna opruga cilindra - (prednja) FAP		Opruga - pokazivač gabarita na blatobranu kamiona	
KB. 212 498 interni broj: 46		interni broj: 84	
Opruga papuče kočnice prednje i zadnje osovine FAP		Povratna opruga paknova kočnice FAP-1921; MERCEDES-26 28	
KB. 212 621 interni broj: 39		KB. 617 993 06 10 interni broj: 97	
Opruga ventila (veća) FAP		Opruga kočnice MERCEDES FAP;	
interni broj: 32		KB. 159 936 210 interni broj: 101	
Opruga ventila (manja) FAP		Opruga gasa MERCEDES	
interni broj: 31		KB. 317 993 10 10 interni broj: 102	
Opruga gasa (manja) FAP		Opruga potisne korpe kvačila FAP	
KB. 210 289 interni broj: 16		interni broj: 107	
Opruga veća		Opruga zadnjeg membranskog cilindra FAP; SANOS 115	
KB. 200 649 interni broj: 41		KB. 206 447 10/1 interni broj: 108	
Povratna opruga S-14 cilindra paknova FAP; SANOS		Opruga prednjeg membranskog cilindra FAP; SANOS 115	
KB. 216 630 interni broj: 40		KB. 206 441 50-1/1 interni broj: 109	
Opruga jabučice SANOS		Opruga paknova pogonske osovine FAP;	
interni broj: 105		617 993 06 10 interni broj: 333	

MERCEDES 1213 - 1216

Opruga kočnice MERCEDES		Opruga anker platne MERCEDES 1213-1216	
KB. 159 936 210 interni broj: 101		KB. 385 993 05 10 interni broj: 58	
Opruga gasa MERCEDES		Opruga paknova prednjih kočnica MERCEDES 1213-1216	
KB. 317 993 10 10 interni broj: 102		KB. 346 993 00 10 interni broj: 59	
Opruga gasa MERCEDES 1213-1216		Opruga paknova zadnjih kočnica MERCEDES 1213-1216	
interni broj: 56		KB. 360 993 01 10 interni broj: 71	
Opruga anker platne MERCEDES 1213-1216			
KB. 360 993 01 01 interni broj: 57			

MERCEDES 2232

Opruga paknova prednjih kočnica MERCEDES 2232		Opruga klizača menjača MERCEDES	
KB. 346 993 02 10 interni broj: 72		KB. 003 993 92 01 interni broj: 82	
Opruga paknova zadnjih kočnica MERCEDES 2232		Opruga - pokazivač gabarita na blatobranu kamiona	
KB. 346 993 03 10 interni broj: 73		interni broj: 84	
Opruga sedišta voza-a MERCEDES 2232		Opruga AC pumpe BOSCH (manja) MERCEDES 2232	
KB. DER BU 5000 interni broj: 74		interni broj: 85	

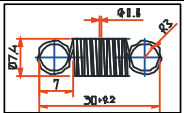
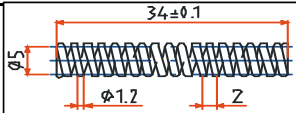
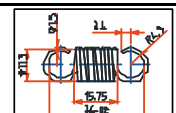
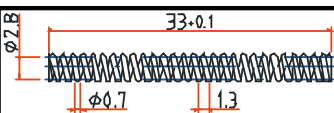
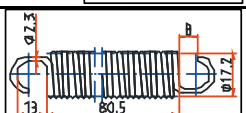
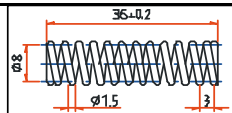
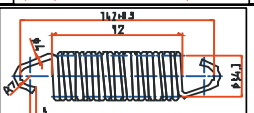
<p>Opruga šelunga 2T za excentar pakna MERCEDES 0.302</p> <p>interni broj: 62</p>	<p>Natezna opruga u bravi ručice MERCEDES 2232/1213</p> 
<p>Opruga klizača menjača (veća) MERCEDES 2232</p> <p>KB. 336 264 06 93</p> <p>interni broj: 79</p> 	<p>Natezna opruga MERCEDES 2232</p> <p>interni broj: 78</p> 
<p>Opruga klizača menjača (manja) MERCEDES 2232</p> <p>KB. 336 264 07 93</p> <p>interni broj: 80</p> 	<p>Opruga gasa MERCEDES; OM 441 402</p> <p>interni broj: 183</p> 
<p>Opruga klizača menjača MERCEDES</p> <p>KB. 002 993 75 01</p> <p>interni broj: 81</p> 	<p>Opruga cilindra pakna zadnjeg točka MERCEDES</p> <p>interni broj: 65</p> 

IKARBUS

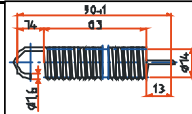
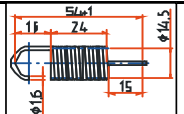
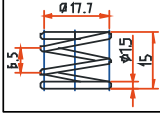
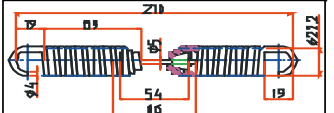
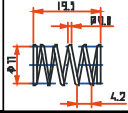
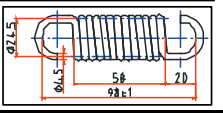
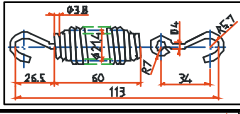
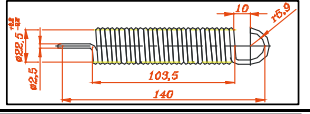
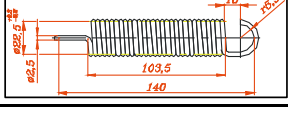
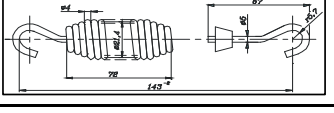
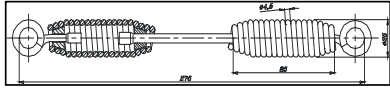
<p>Opruga duža IKARBUS</p> <p>KB. 108 106 931</p> <p>interni broj: 171</p> 	<p>Opruga kraća IKARBUS</p> <p>KB. 108 106 980</p> <p>interni broj: 172</p> 
<p>Opruga sita čašice IKARBUS</p> <p>KB. 108 133 887</p> <p>interni broj: 159</p> 	<p>Opruga IKARBUS</p> <p>KB. 108 138 926</p> <p>interni broj: 162</p> 
<p>Opruga sita čašice IKARBUS</p> <p>KB. 108 207 572</p> <p>interni broj: 160</p> 	<p>Opruga paknova IKARBUS</p> <p>KB. 108 136 201</p> <p>interni broj: 163</p> 
<p>Opruga IKARBUS</p> <p>KB. 108 136 193</p> <p>interni broj: 161</p> 	<p>Opruga kočione pakne - prednja IKARBUS - GSB</p> <p>KB. 108 107 554</p> <p>interni broj: 334</p> 
<p>Opruga kočione pakne - zadnja IKARBUS - GSB</p> <p>KB. 108 126 087</p> <p>interni broj: 335</p> 	<p>Opruga kočione pakne -kraća IKARBUS</p> <p>KB. 860 00 3341 040</p> <p>interni broj: 336</p> 
<p>Opruga kočione pakne -duža IKARBUS</p> <p>KB. 007.10-3341-049</p> <p>interni broj: 337</p> 	

PRIKOLICE "ITAS"

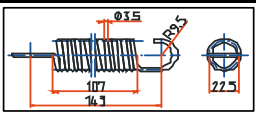
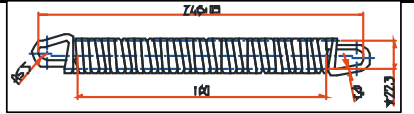
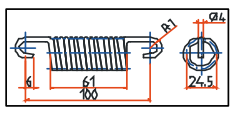
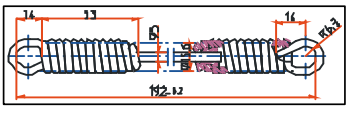
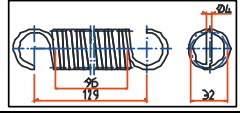
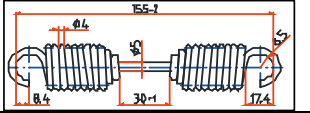
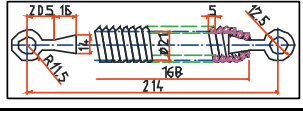
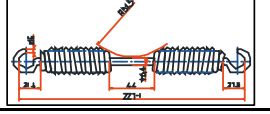
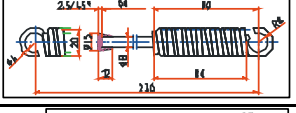
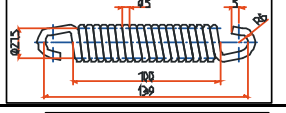
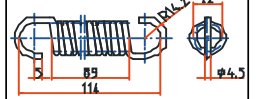
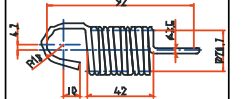

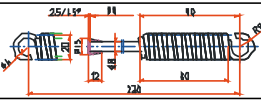
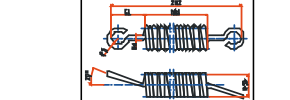
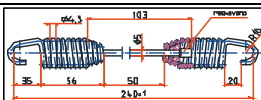
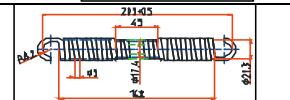
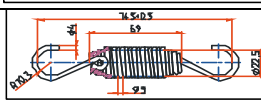
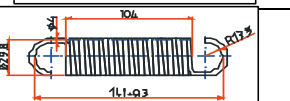
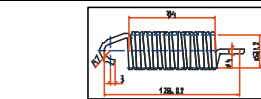
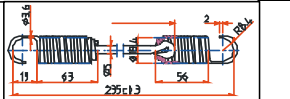
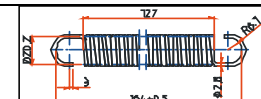

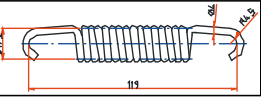
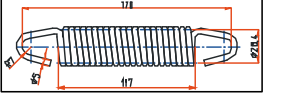
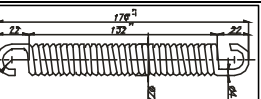
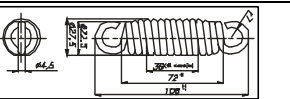
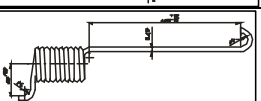
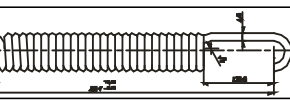

<p>Natezna opruga za povratak ključa PP GOŠA FRUKOF - ITAS 26T</p> <p>KB. AJU 0171 X KB. 11 01 007</p> <p>interni broj: 53</p> 	<p>Opruga pakna GORICA 277</p> <p>interni broj: 149</p> 
<p>Natezna opruga paknova kočnica PP ITAS 26T</p> <p>KB. 214 10 007</p> <p>interni broj: 54</p> 	<p>Opruga pakna - najmanja (dupla) TSH GORICA</p> <p>interni broj: 148</p> 
<p>Natezna opruga za povratak ključa PP ITAS 26T</p> <p>KB. 214 10 007</p> <p>interni broj: 55</p> 	<p>Opruga GOSA</p> <p>KB. A JU 0447</p> <p>interni broj: 178</p> 
<p>Natezna opruga za povratak ključa PP GOŠA tip 1979. Kiper 26T</p> <p>interni broj: 68</p> 	<p>Opruga GO[A]</p> <p>KB. A JU 0578</p> <p>interni broj: 179</p> 
<p>Natezna opruga paknova kočnica PP ITAS 26T - novi tip (kiper)</p> <p>interni broj: 51</p> 	<p>Opruga pakna ITAS R8</p> <p>interni broj: 145</p> 
<p>Natezna opruga paknova kočnica PP ITAS 22T; GOŠA 26T (1979god.)</p> <p>KB. 11 11 001</p> <p>interni broj: 52</p> 	<p>Opruga cilindra (tanja) GO[A] - FRUKOF</p> <p>3102 73 294</p> <p>interni broj: 146</p> 

<p>Natezna opruga paknova kočnica GORICA 22N - 1</p> <p>interni broj: 66</p>		<p>Opruga kiper prikolice Slovenački kiper</p> <p>interni broj: 175</p>	
<p>Natezna opruga paknova kočnica GOŠA - FRUKOF</p> <p>interni broj: 60</p>		<p>Opruga paknova prikolica UTVA 200 026 1</p> <p>interni broj: 114</p>	
<p>Opruga cilindra (tanja) GORICA</p> <p>interni broj: 151</p>		<p>Natezna opruga GO[A] KB. A JU 0543</p> <p>interni broj: 147</p>	
<p>Opruga cilindra (deblja) GORICA</p> <p>interni broj: 150</p>		<p>Opruga prednjih paknova GORICA - D' AMBO</p> <p>interni broj: 49</p>	
<p>Opruga cilindra GORICA T10; RABA</p> <p>interni broj: 315</p>			

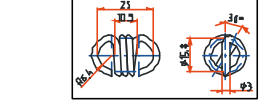
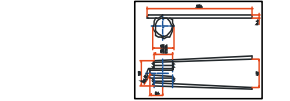
SETRA; NEOPLAN I SCANIA

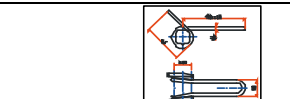
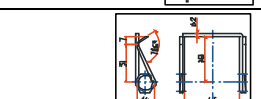
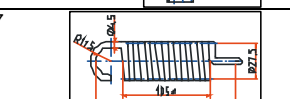
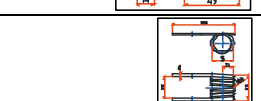
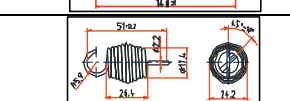
<p>Opruga paknova zadnje osovine SETRA; NEOPLAN</p> <p>interni broj: 319</p>		<p>Opruga paknova zadnje osovine SETRA; NEOPLAN</p> <p>interni broj: 320</p>	
<p>Opruga paknova SETRA</p> <p>interni broj: 322</p>		<p>Opruga pakna prednjeg točka SCANIA 112 (od 1998.god.)</p> <p>interni broj: 321</p>	
<p>Opruga hidrauličnog kočenja SETRA</p> <p>interni broj: 325</p>		<p>Opruga hidrauličnog kočenja SETRA</p> <p>interni broj: 326</p>	

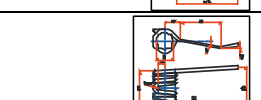
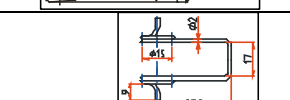
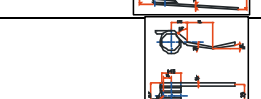
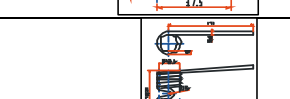
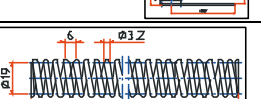
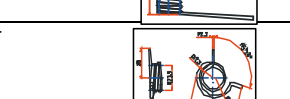
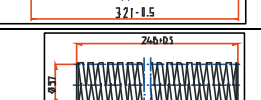
TRAKTORI I POLJOPRIVREDNE MAŠINE

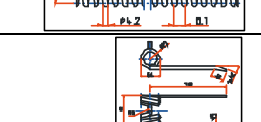
<p>Opruga kočnice IMT 558 KB. 550 01 733</p> <p>interni broj: 26</p>		<p>Dvokraka opruga za sakupljač sena Kombajn PANONIJA KB. 349 200 501</p> <p>interni broj: 91</p>	
<p>Opruga pipka IMT 558 KB. 550 04 109</p> <p>interni broj: 25</p>		<p>Opruga za baliranje sena presa za baliranje LIFAM</p> <p>interni broj: 302</p>	
<p>Opruga kvačila ZETOR interni broj: 83</p>		<p>Opruga sedišta IMT 577</p> <p>interni broj: 135</p>	
<p>Dvokraka opruga za sakupljač sena Kombajn FAVORIT (novi) KB. 349 201 501</p> <p>interni broj: 90</p>		<p>Opruga druk ležaja Traktor; kultivator</p> <p>interni broj: 180</p>	
<p>Opruga kombajna za grašak FMC-S 7055 180 073</p> <p>interni broj: 133</p>		<p>Opruga za slamu Poljostroj</p> <p>interni broj: 327</p>	
<p>Opruga kombajna za grašak HERBORT KB. 2012</p> <p>interni broj: 136</p>		<p>Opruga za motokultivator</p> <p>interni broj: 184</p>	
<p>Opruga kosačica za spanaj interni broj: 134</p>		<p>Dvokraka opruga za detelinu ZMAJ - HESTOG (stari tip)</p> <p>interni broj: 186</p>	
<p>Opruga za sejačicu `ita IMT 634 23</p> <p>interni broj: 119</p>		<p>Opruga veja Viljukar</p> <p>interni broj: 181</p>	
<p>Opruga sedišta seja-ica OLTOVES interni broj: 113</p>		<p>Opruga manja Viljukar</p> <p>interni broj: 182</p>	
<p>Opruga za seno STARI TAMIŠ interni broj: 110</p>			

OPRUŽNI OSIGURAČI I KARIKE ZA KLJUČEVE

Opružni osigurač interni broj: 138	2 x 50		Opružni osigurač interni broj: 139	4 x 60																			
Opružni osigurač 138-1	3 x 60		Opružni osigurač interni broj: 140	5 x 85																			
Opružni osigurač interni broj: 141	6 x 105		Opružni osigurač interni broj: 143	8 x 110																			
Opružni osigurač interni broj: 142	7 x 105		Opružni osigurač interni broj: 144	9 x 160																			
Karike za ključeve interni broj: 177	<table border="1"> <thead> <tr> <th>Ø A</th> <th>10</th> <th>12</th> <th>14</th> <th>18</th> <th>20</th> <th>22</th> <th>24</th> <th>30</th> </tr> </thead> <tbody> <tr> <td>CENA</td> <td>0,87</td> <td>0,87</td> <td>1,30</td> <td>1,30</td> <td>1,30</td> <td>1,30</td> <td>1,30</td> <td>2,16</td> </tr> </tbody> </table>					Ø A	10	12	14	18	20	22	24	30	CENA	0,87	0,87	1,30	1,30	1,30	1,30	1,30	2,16
Ø A	10	12	14	18	20	22	24	30															
CENA	0,87	0,87	1,30	1,30	1,30	1,30	1,30	2,16															

OPRUGE ZA ŠPORETE

Opruga vrata - leva interni broj: 153	IGO		Opruga vrata reme - leva i desna RADE KONČAR interni broj: 305	
Opruga vrata - desna interni broj: 154	IGO		Opruga vrata RADE KONČAR (profesional) interni broj: 306	
Opruga vrata reme - desna RADE KONČAR interni broj: 111		Opruga vrata reme SMEDEREVAC (električni) interni broj: 48		
Opruga vrata reme - leva RADE KONČAR interni broj: 111-L		Opruga vrata reme - leva i desna MILAN BLAGOJEVIĆ leva: 700026; desna: 700027 interni broj: 316		
Opruga vrata reme - leva ARTUR MARTEN interni broj: 112		Opruga vrata reme - leva i desna MILAN BLAGOJEVIĆ leva: 60 01 00 02; desna: 60 02 00 02 interni broj: 317		
Opruga vrata reme - desna KOVINOSTROJ-GROSUPLJE interni broj: 152		Opruga vrata reme - leva i desna MILAN BLAGOJEVIĆ KB. 857 13 12 02 interni broj: 318		
Opruga vrata reme - leva KOVINOSTROJ - GROSUPLJE interni broj: 152 - L		Opruga vrata reme - leva i desna ELEKTROLUX interni broj: 323		

RAZNE OPRUGE

Natezna opruga sa kukama ŠTAMPARSKA MAŠINA 8 x 55 x 220 interni broj: 115		Opruga za štupaljku interni broj: 165	
Opruga otvora na krovu BUS interni broj: 64		Opruga snega - Vojvodina put interni broj: 197	
Opruga pakna GORICA - D'ambo (1990.god.) interni broj: 155		Opruga avionskog sedišta leva i desna interni broj: 121	

<p>Opruga</p> <p>interni broj: 156</p>		<p>Opruga el. uređaja za spravljanje hrane STIL INŽENJERING</p> <p>interni broj: 176</p>	
<p>Opruga noćne pumpe FADIP - Be-ej</p> <p>interni broj: 189</p>		<p>Povratna opruga zadnjih paknova OPEL - Kadet 1976.god.</p> <p>interni broj: 118</p>	
<p>Opruga vazdušne puške ČEŠKA</p> <p>interni broj: 199</p>		<p>Opruga prednjih i zadnjih paknova RENO 4</p> <p>interni broj: 120</p>	
<p>Opruga vazdušne puške ZASTAVA</p> <p>interni broj: 200</p>		<p>Opruga zadnjih paknova FORD - Transitz</p> <p>interni broj: 47</p>	
<p>Opruga sa jabučicom OBOD - veš mašina</p> <p>interni broj: 166</p>		<p>Opruga kvačila VOLVO</p> <p>interni broj: 50</p>	
<p>Spajalica za papir L=78mm</p> <p>interni broj: 194</p>		<p>Opruga sa kukom BEOKOMERC 1792 590 02 00</p> <p>interni broj: 301</p>	
<p>Konusna opruga sedišta BUS - Niš expres</p> <p>interni broj: 185</p>		<p>Opruga za rigištu</p> <p>interni broj: 303</p>	
<p>Opruga za automobilsku antenu</p> <p>interni broj: 106</p>		<p>Opruga za seno - dvokraka SUNCE</p> <p>interni broj: 304</p>	
<p>Opruga stomak eliminatora</p> <p>interni broj: 100</p>		<p>Opruga za veš mašinu OBOD</p> <p>interni broj: 313</p>	

OPRUGE ZA LEŽAJEVE I KAUČE

<p>Opruga za ležaj L = 86mm</p> <p>interni broj: 190</p>		<p>Opruga kauča</p> <p>interni broj: 188</p>	
<p>Opruga za ležaj L = 66mm</p> <p>interni broj: 191</p>		<p>Opruga za makaze troseda</p> <p>interni broj: 67</p>	
<p>Opruga za ležaj L = 60mm</p> <p>interni broj: 192</p>		<p>Opruga kauča</p> <p>interni broj: 164</p>	
<p>Opruga kauča</p> <p>interni broj: 187</p>			

OPRUGE ZA GARAŽNA VRATA

<p>Opruga za garažna vrata</p> <p>interni broj: 196</p>		<p>Opruga za garažna vrata (leva i desna)</p> <p>interni broj: 198</p>	
<p>Opruga L = 540mm za aluminijumska vrata</p> <p>interni broj: 329</p>		<p>Opruga L = 600mm za aluminijumska vrata</p> <p>interni broj: 329-1</p>	

OSNOVNI PODACI O FIRMI **OPRUGE PIKIĆ DOO**

NAZIV:	PRIVREDNO DRUŠTVO ZA PROIZVODNJU, PROMET I USLUGE OPRUGE PIKIĆ, D.o.o. Beograd-Voždovac
SKRAĆENI NAZIV:	OPRUGE PIKIĆ D.O.O. Beograd-Voždovac
ADRESA:	Pčinjska 19, 11050 BEOGRAD
TELEFON:	011-7860219
e-mail ADRESA:	office@oprugepikic.rs
SAJT:	www.oprugepikic.rs
MATICNI BROJ:	20946253
SIFRA DELATNOSTI:	2593 (proizvodnja žičanih proizvoda, lanaca i opruga)
TEKUCI RACUN:	160-393463-80
PIB:	108176917
DATUM REGISTRACIJE:	31.7.2013.
APR BROJ:	BD 83593/2013
IME DIREKTORA:	MILA PIKIĆ

